

Feed/Alarm Set Points

Press the  key **once** to view **Feed Set Points**.

Press the  key **again** to view **Alarm Set Points**.

To adjust a Set Point, press the number key associated with that Set Point. Use the numeric keypad to enter the desired value. Press Enter to confirm.

Alarm Status

An alarm condition will be indicated by a bright-red flashing LED. Specific alarm(s) will be listed on the bottom portion of the display.

Feed Status

Current chemical feed status is indicated on the front panel with green indicator LEDs.

- ◆ **On** - Feeding
- ◆ **Off** - Not feeding
- ◆ **Flashing** - Not feeding, during the "paused" cycle of time-based-proportional feed mode.

Relay Mode

Press the  key.

Current Relay Modes are displayed.

- ◆ **MANUAL ON** - Relay is forced on, overriding the BECSys5 control decision. (As a safety feature, relay will not remain on longer than Failsafe Timer setting.)
- ◆ **MANUAL OFF** - Relay is forced off, overriding the BECSys5 control decision.
- ◆ **AUTO** - Allow the BECSys5 to control the relay.

Stop feeds immediately

An important safety feature of the BECSys5 is the ability to stop all control operations immediately. To do this, press the  key.

A red LED will indicate that all feeds and control operations are halted.

To resume normal control, press the  key again.

Calibrate Inputs

Press the  key.

Press the number key to select the input to be calibrated. Use the numeric keypad to enter the desired value. Press Enter to confirm.

Reset Fail/Safe Alarm(s)

A Fail/Safe alarm, indicated with a flashing red LED, occurs when the BECSys5 has halted chemical feed because a programmed feed time limit has been reached.

Press the  to list the active FailSafe alarms.

Correct the conditions that created the Failsafe alarm, return to this screen, and select "Reset" by pressing .

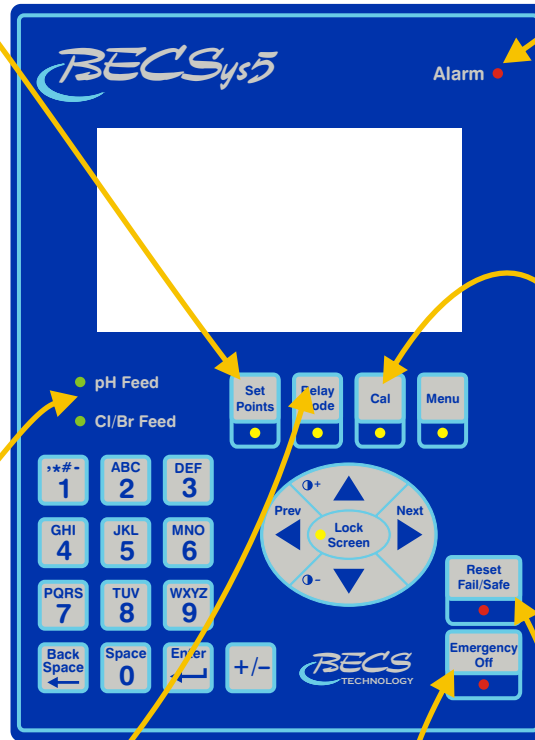

Advanced Relay Mode

Press the  key.

Tip: To test a relay or to prime a pump, lock the screen while in the main Relay Mode menu, then press the relay's numeric key (i.e., for relay 3, press the 3 key).

This will turn the relay on for as long as you are pressing that key. If the relay is already on, this will have no effect.

Menu Operation

Press the  key.

If access codes are enabled, you must enter your code to proceed.

When in menus, use the Up ▲ and Down ▼ buttons, and Help information on the right side of the screen will guide you.

Text Data Entry

The Numeric keypad also includes letters and special characters. Press the key multiple times to scroll through letters and special characters as indicated. Feature is only enabled for non-numeric parameters.

Lock Screen

When in the **Normal Display**, press the Lock Screen to prevent the controller from scrolling to the next page. The yellow LED will turn on. Press the Lock Screen button again to resume scrolling.

When in **Menu Mode**, pressing the Lock Screen key will give 3 options in a pop-up box:

1. Lock - press  to Lock Screen. Yellow LED will be lit.

2. Logoff - press  to logoff current user and return to Normal Display.

3. Cancel - press  to return to previous menu.



Tip: The current user is displayed above the 3 options.



Tip: While the screen is locked in Menu Mode, use the ▲ and ▼ keys to scroll through help text that does not fit on one page.

Tip: Press and hold the Lock Screen button for 1 second to lock screen without the pop-up box. The system will beep 3 times to confirm.

Adjust Contrast

The Up Arrow ▲ and Down Arrow ▼ keys may also be used to adjust the screen contrast at any time.

These keys are also labeled + and - to identify this feature.

Press and hold either + or - for 2 seconds, until the system beeps 3 times.

Now use the + and - keys to darken and lighten the display.

Normal Display

When in Normal Display, the system will display all inputs and operating conditions. When there is more information that can fit on one screen, the system will scroll through multiple pages.

Alarms, if active, will be displayed on the bottom section of the screen.

Tip: Use the ▲ and ▼ keys to increase or decrease the scroll rate while in the Normal Display.

